

# Model 02 PK - Lobe Knob Male:

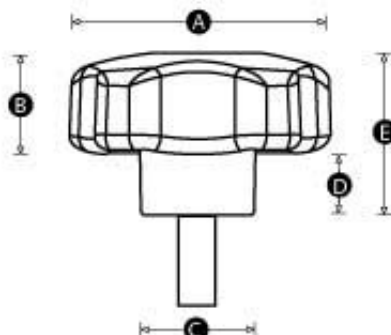

## Actions / Downloads:

- [Print](#)



**Material:** High impact resistant thermoplastic

**Standard Colour:** Black

**Finish:** Matt

**Male Thread Material:** Zinc plated steel

**Cap Colours:** Available with caps in many different colours (MOQs apply).



**NEXT-DAY UK DELIVERY ON STOCK ITEMS**













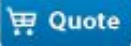

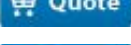
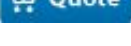
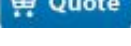
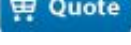

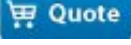
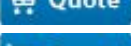
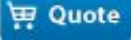
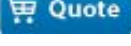
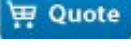
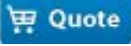

**INTERNATIONAL SHIPPING**







Please refer to the table below for types and sizes of this product. Once you have found the exact component you require, select the 'Quote' button. In the fields provided, enter the quantity you require and add any special options or non-standard colours / threads.

**We will reply by email within one working day with a price and delivery schedule.**

PATTERN	PART NO.	A	B	C	D	E	Thread size	Thread length (mm)	Material	Thread material	Stocked Item	MOQ	QUOTE REQUEST
3128/M	10825W	28	16	14	9	25	M5	10	Nylon GF	Steel	No	500	<a href="#">Quote</a>
3128/M	10826S	28	16	14	9	25	M5	15	Nylon GF	Steel	Yes	500	<a href="#">Quote</a>
3128/M	10827Z	28	16	14	9	25	M5	20	Nylon GF	Steel	No	500	<a href="#">Quote</a>
3128/M	10828V	28	16	14	9	25	M6	10	Nylon GF	Steel	No	500	<a href="#">Quote</a>
3128/M	10829R	28	16	14	9	25	M6	15	Nylon GF	Steel	No	500	<a href="#">Quote</a>

3128/M	14311T	28 16 14 9	25 M6	15	PP	SS	Yes	10	
3128/M	10830Y	28 16 14 9	25 M6	20	Nylon GF	Steel	No	500	
3128/M	14293Z	28 16 14 9	25 M6	20	PP	Steel	Yes	10	
3128/M	14312P	28 16 14 9	25 M6	20	PP	SS	Yes	10	
3140/M	10836W	40 17 18 12 29	M6	15	Nylon GF	Steel	No	500	
3140/M	11181R	40 17 18 12 29	M6	20	Nylon GF	Steel	No	500	
3140/M	10837S	40 17 18 12 29	M6	25	Nylon GF	Steel	No	500	
3140/M	10839V	40 17 18 12 29	M8	15	Nylon GF	Steel	No	500	
3140/M	10840R	40 17 18 12 29	M8	25	Nylon GF	Steel	No	500	
3140/M	14294V	40 17 18 12 29	M6	25	PP	Steel	Yes	10	
3140/M	14313W	40 17 18 12 29	M6	25	PP	SS	Yes	10	
3140/M	14295R	40 17 18 12 29	M8	20	PP	Steel	Yes	10	
3140/M	14314S	40 17 18 12 29	M8	20	PP	SS	Yes	10	
3140/M	14296Y	40 17 18 12 29	M8	30	PP	Steel	Yes	10	
3140/M	14315Z	40 17 18 12 29	M8	30	PP	SS	Yes	10	
3140/M	10841Y	40 17 18 12 29	M8	35	Nylon GF	Steel	No	500	
3150/M	10847W	50 19 21 12 31	M6	20	Nylon GF	Steel	No	500	
3150/M	11182Y	50 19 21 12 31	M6	25	Nylon GF	Steel	No	500	
3150/M	10848S	50 19 21 12 31	M6	35	Nylon GF	Steel	No	500	
3150/M	11183U	50 19 21 12 31	M8	25	Nylon GF	Steel	No	500	
3150/M	10851R	50 19 21 12 31	M8	35	Nylon GF	Steel	No	500	
3150/M	10852Y	50 19 21 12 31	M8	40	Nylon GF	Steel	No	500	
3150/M	11184Q	50 19 21 12 31	M10	25	Nylon GF	Steel	Yes	500	
3150/M	11185X	50 19 21 12 31	M10	35	Nylon GF	Steel	No	500	
3150/M	11186T	50 19 21 12 31	M10	40	Nylon GF	Steel	No	500	
3150/M	14297U	50 19 21 12 31	M8	25	PP	Steel	Yes	10	
3150/M	14316V	50 19 21 12 31	M8	25	PP	SS	Yes	10	
3160/M	10858W	60 21 21 13 34	M8	20	Nylon GF	Steel	No	500	
3160/M	10859S	60 21 21 13 34	M8	30	Nylon GF	Steel	No	500	
					Nylon				

3160/M	10860Z	60 21 21 13 34 M8	40	GF	Steel	No	500	
3160/M	10861V	60 21 21 13 34 M10	20	Nylon GF	Steel	No	500	
3160/M	10862R	60 21 21 13 34 M10	30	Nylon GF	Steel	No	500	
3160/M	10863Y	60 21 21 13 34 M10	40	Nylon GF	Steel	No	500	
3160/M	14298Q	60 21 21 13 34 M10	25	PP	Steel	Yes	10	
3160/M	14317R	60 21 21 13 34 M10	25	PP	SS	Yes	10	
3160/M	11188W	60 21 21 13 34 M12	30	Nylon GF	Steel	No	500	
3160/M	14299X	60 21 21 13 34 M12	30	PP	Steel	Yes	10	
3160/M	14318Y	60 21 21 13 34 M12	30	PP	SS	Yes	10	
3160/M	11189S	60 21 21 13 34 M12	40	Nylon GF	Steel	No	500	
3160/M	11190Z	60 21 21 13 34 M12	50	Nylon GF	Steel	No	500	

© Rencol Components Ltd. Company No. 07043676