

Model 07 CR - Cranking Handle:

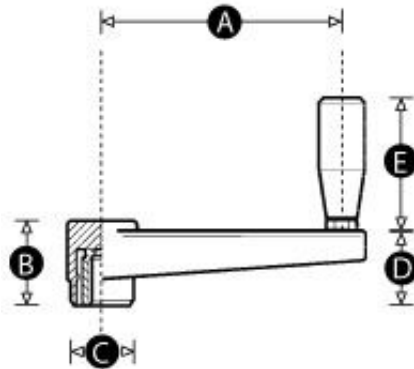

Actions / Downloads:

- [Print](#)



Material: High impact resistant thermoplastic

Standard Colour: Black

Finish: Matt

Female Insert Material: Brass



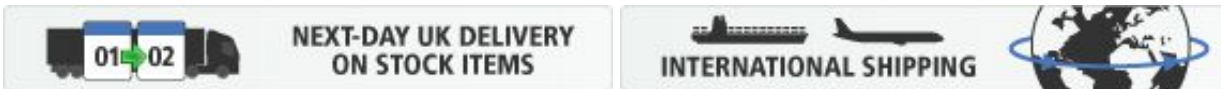





Handle: Non-folding revolving side handle



Please refer to the table below for types and sizes of this product. Once you have found the exact component you require, select the 'Quote' button. In the fields provided, enter the quantity you require and add any special options or non-standard colours / threads.

We will reply by email within one working day with a price and delivery schedule.

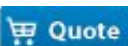
PATTERN	PART NO.	A	B	C	D	Thread size	Square Bore (mm)	Stocked	Item	MOQ	QUOTE REQUEST
5565	6709T	65	31	26	32	M8	n/a	No		10	Quote
5565	7611T	65	31	26	32	M10	n/a	No		10	Quote
5565	7610X	65	31	26	32	M12	n/a	No		10	Quote
5580	6710P	80	33	30	33	M8	n/a	No		10	Quote
5580	6741X	80	33	30	33	M10	n/a	No		10	Quote
5580	7609Q	80	33	30	33	M12	n/a	No		10	Quote
55110	14192W	110	39	33	39	n/a	12	Yes		5	Quote

55110	6711W	110 39 33 39 M10	n/a	No	10	
55110	7612P	110 39 33 39 M12	n/a	No	10	
55110	9446Q	110 39 33 39 M14	n/a	No	10	
55140	6712S	140 49 42 50 M12	n/a	No	10	
55140	9447X	140 49 42 50 M14	n/a	No	10	
55140	7608U	140 49 42 50 M16	n/a	No	10	
55185	6713Z	185 54 46 58 M12	n/a	No	10	
55185	9850R	185 54 46 58 M14	n/a	No	10	
55185	7607Y	185 54 46 58 M16	n/a	No	10	

© Rencol Components Ltd. Company No. 07043676