

SPRING HINGE



JSA



- Spring loaded for self closing.
- Adjustable spring tension.
- Successfully passed 500,000 open/close private cycle tests.

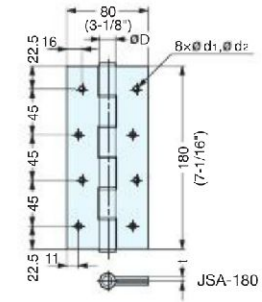
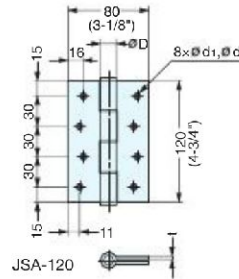

JSA-120A

JSA-180S

Installation

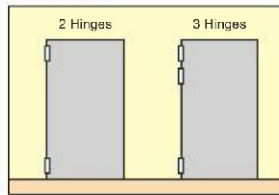

Adjustable Spring tension

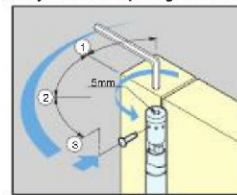

Self closing

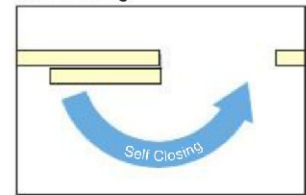

Item No.	D	t	d ₁	d ₂	Load Capacity (kg)		Weight (g)	Box (pcs)	Carton (pcs)	Material	Finish
					2 Hinges	3 Hinges					
JSA-120A	16	4	5	8	20 (44 lbs)	30 (66 lbs)	175	2	20	Aluminum	Anodized
JSA-180A					40 (88 lbs)	60 (132 lbs)	260				
JSA-120S	17	2.5	5.5	9	20 (44 lbs)	30 (66 lbs)	303	2	20	304 Stainless Steel	Satin
JSA-180S	18	3			40 (88 lbs)	60 (132 lbs)	526				

SPRING HINGE



JST-150S



JST-150S

- Spring loaded for self closing.
- Adjustable spring tension.
- Successfully passed 500,000 open/close private cycle tests.

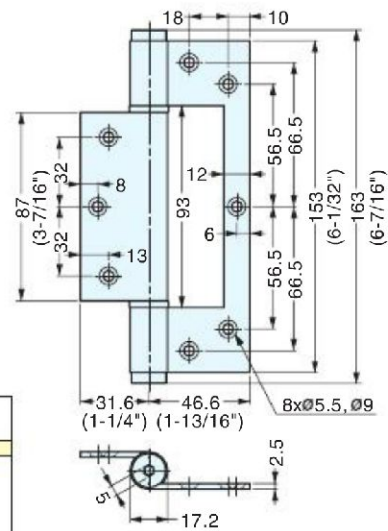

Installation

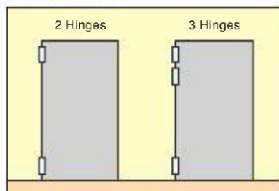

Adjustable Spring tension

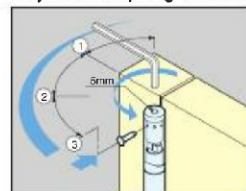

Self closing

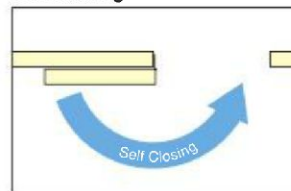

Item No.	Load capacity (kg)		Weight (g)	Box (pcs)	Carton (pcs)	Material	Finish
	2 Hinges	3 Hinges					
JST-150S	40 (88 lbs)	60 (132 lbs)	336	2	20	304 Stainless steel	Satin

DOUBLE ACTION SPRING HINGE



JDA



JDA-120-30A

JDA-180-38S

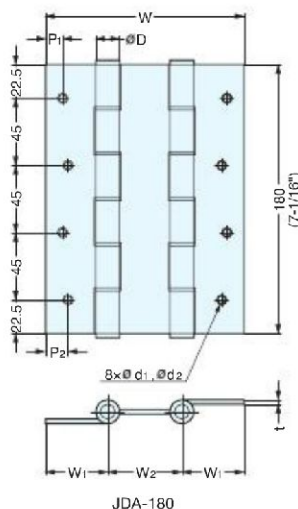

JDA-180

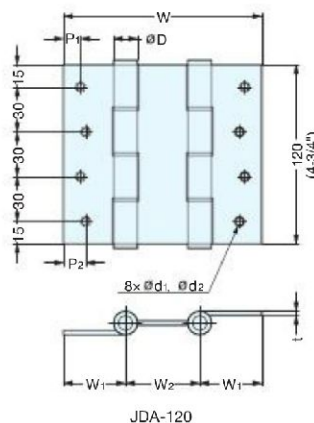

JDA-120

- Spring loaded for self closing.
- Adjustable spring tension.
- Successfully passed 500,000 open/close private cycle tests.

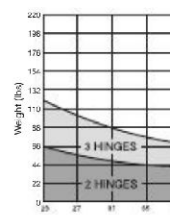

JDA-120-30A

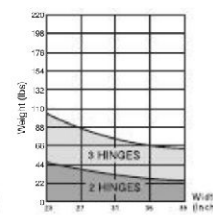

JDA-120-40A
JDA-120-36S

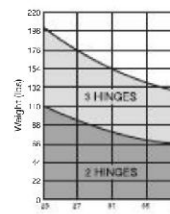

JDA-180-30A

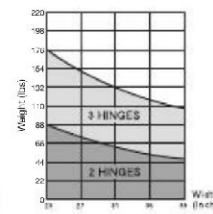

JDA-180-40A
JDA-180-38S

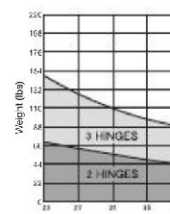

JDA-180-50A

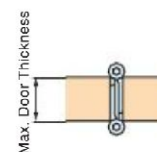

Installation

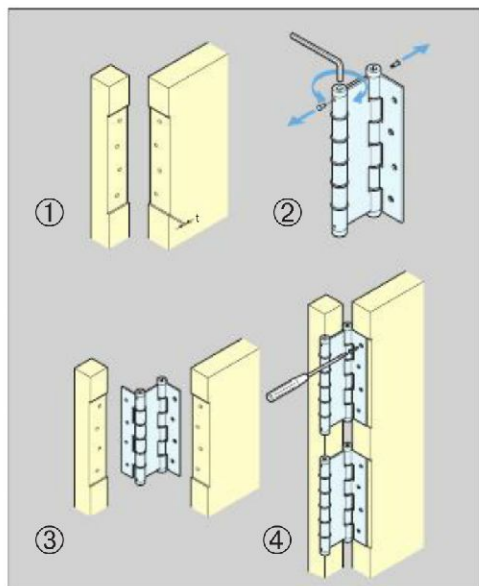

Adjustable Spring tension

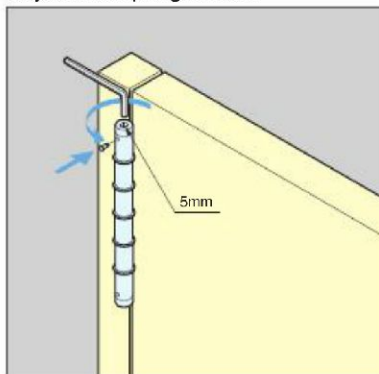

Double Action Spring Hinges

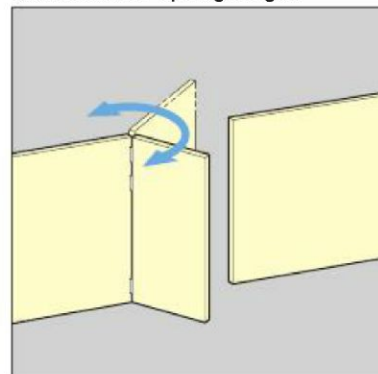

Item No.	W	W ₁	W ₂	P ₁	P ₂	D	t	d ₁	d ₂	Max. Door Thickness (mm)	Weight (g)	Material	Finish	Box (pcs)	Carton (pcs)
JDA-120-30A	101 (4")	29.5	42	6.5	11.5	16	4	5	8	30 (1-3/16")	275	Aluminum	Anodized	2	20
JDA-120-40A	133 (5-1/4")	40	53	11	16					40 (1-9/16")	320				
JDA-180-30A	101 (4")	29.5	42	6.5	11.5					30 (1-3/16")	407				
JDA-180-40A	133 (5-1/4")	40	53	11	16					40 (1-9/16")	466				
JDA-180-50A	157 (6-3/16")	48.5	60	19.5	24.5	50 (1-31/32")	510	304 Stainless Steel	Satin						
JDA-120-36S	133 (5-1/4")	40	53	11	16	17	2.5					5.5	9	36 (1-13/32")	555
JDA-180-38S						18	3							38 (1-1/2")	947

DOUBLE ACTION SPRING HINGE



JDAW



JDAW-120-35A

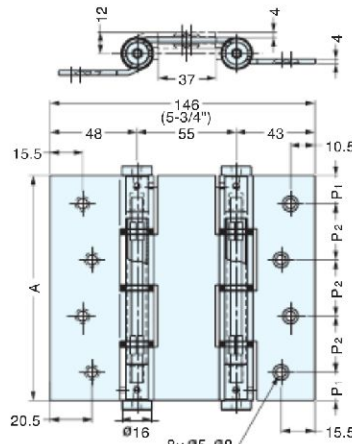

- Spring loaded for self closing.
- Adjustable spring tension.

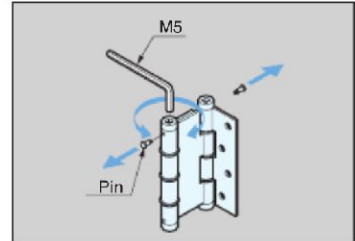
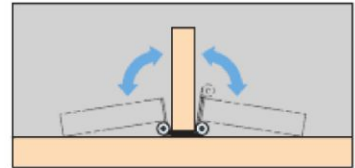

Spring Adjustment

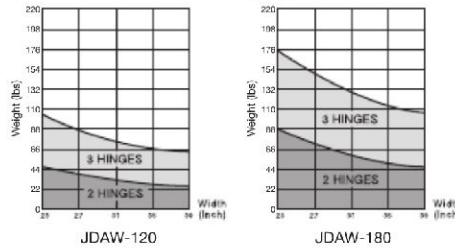

Item No.	A	P ₁	P ₂	Door Thickness	Weight (g)	Box (pcs)	Carton (pcs)	Material	Finish
JDAW-120-35A	120 (4-3/4")	15	30	35 mm (1-3/8")	350	2	20	Aluminum	Anodized
JDAW-180-35A	180 (7-1/16")	22.5	45						

OTHER SPRING HINGES FOR SMALL DOORS AND CABINETRY



HG-SH P. 221



SH P. 221



HG-PV60AC P. 223



HG-BF3 P. 223

www.sugatsune.com

LAMP
by SUGATSUNE

1-800-562-5267
(U.S.A. Only)