

## M Series Castor Wheels – Bolt Hole

- Up to 110kg load rating per castor
- Strong pressed steel construction
- Zinc plate finish
- Total lock & directional lock options
- Four wheel types
- Common Uses: Food preparation areas, Light factory equipment, Hospital equipment, Warehouse trolleys, Shop fitting, Cabinet making

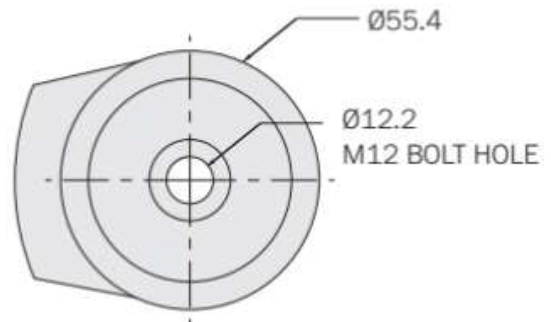

SWIVEL



TOTAL LOCKING



DIRECTIONAL LOCKING



### BPB

- » Resilient blue rubber tread
- » Polypropylene centre
- » Precision bearings



### NNI

- » Virgin nylon 6 tread
- » Nylon centre
- » Plain bore and POM bushing



### TPB











- » Thermoplastic elastomer tread
- » Polypropylene centre
- » Precision bearings







### UPB

- » Polyurethane tread
- » Polypropylene centre
- » Precision bearings

## MOUNTING TYPE

WHEEL DIAMETER (mm)	MOUNTING TYPE	FRAME CODE	WHEEL ABR	MAX LOAD (KG)	WHEEL ABR	MAX LOAD (KG)	WHEEL ABR	MAX LOAD (KG)	WHEEL ABR	MAX LOAD (KG)	OVERALL HEIGHT (mm)	SWIVEL RADIUS (mm)
												
75		MZH07532	-BPB	80	-NNI	130	-TPB	80	-UPB	80	111	72
100		MZH10032	-BPB	100	-NNI	140	-TPB	100	-UPB	100	135	78
125		MZH12532	-BPB	110	-NNI	150	-TPB	110	-UPB	110	158	96
150		MZH15032	-BPB	-	-NNI	N/A	-TPB	125	-UPB	125	183	127
200		MZH20032	-BPB	-	-NNI	-	-TPB	150	-UPB	-	243	145
75		MZHT07532	-BPB	80	-NNI	130	-TPB	80	-UPB	80	111	114
100		MZHT10032	-BPB	100	-NNI	140	-TPB	100	-UPB	100	135	
125		MZHT12532	-BPB	110	-NNI	150	-TPB	110	-UPB	110	158	135
150		MZHT15032	-BPB	-	-NNI	-	-TPB	125	-UPB	125	183	
200		MZHT20032	-BPB	-	-NNI	-	-TPB	150	-UPB	-	243	
75		MZHD07532	-BPB	80	-NNI	130	-TPB	80	-UPB	80	111	114
100		MZHD10032	-BPB	100	-NNI	140	-TPB	100	-UPB	100	135	
125		MZHD12532	-BPB	110	-NNI	150	-TPB	110	-UPB	110	158	135
150		MZHD15032	-BPB	-	-NNI	-	-TPB	125	-UPB	125	183	
200		MZHD20032	-BPB	-	-NNI	-	-TPB	150	-UPB	-	243	

## WHEELS

WHEEL DIAMETER (mm)	TREAD WIDTH (mm)	WHEEL CODE	MAX LOAD (KG)	BORE DIAMETER (no spacer mm)	BORE DIAMETER (spacer mm)	HUB LENGTH (mm)	TREAD MATERIAL	CENTRE MATERIAL	BEARING TYPE	AXLE SPACER TYPE
										
75	32	BP07532B	80	8	-	38	BLUE HI RES	PP	PRECISION BEARINGS	
100		BP10032B	100							
125		BP12532B	110							
75	32	NN07532I	130	15	8	38	NYLON	NYLON	PLAIN BORE	
100		NN10032I	140							
125		NN12532I	150							
75	32	TP07532B	80	8	-	38	THERMOPLASTIC ELASTOMER	PP	PRECISION BEARINGS	
100		TP10032B	100							
125		TP12532B	110			40				
150		TP15032B	150							
200		TP20032B	150							
75	32	UP07532B	80	8	-	38	URETHANE	PP	PRECISION BEARINGS	
100		UP10032B	100							
125		UP12532B	110							
150		UP15032B	125							