

## MS Series Castor Wheels – Stainless Steel

- Up to 150kg load rating per castor
- 304 grade stainless steel castor frames
- Choice of 3 different wheel types
- 75mm, 100mm, 125mm & 150mm wheel dia.
- Ideal for harsh Australian conditions
- Non-marking wheel treads
- Total locking brake models available
- Common Uses: Food preparation areas, Marine environments, Hospital equipment, Commercial laundry equipment, Shop fitting, Cabinet making

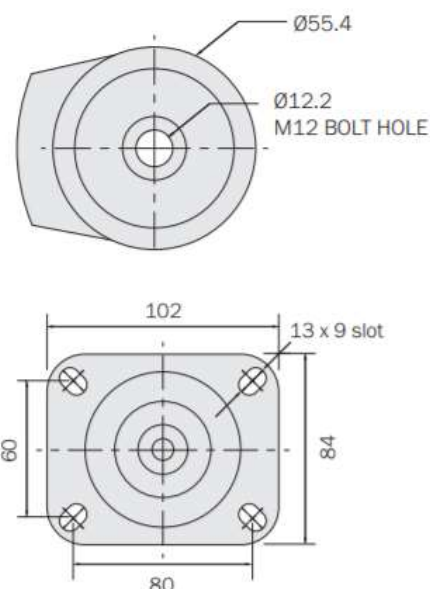

### TPB

- » Thermoplastic elastomer tread
- » Polypropylene centre
- » Stainless steel precision bearings



### UPB













- » Polyurethane tread
- » Polypropylene centre
- » Precision bearings







### NNI

- » Solid virgin nylon 6 tread and centre
- » POM bushing

## MOUNTING TYPE

WHEEL DIAMETER (mm)	MOUNTING TYPE	FRAME CODE	WHEEL ABR	MAX LOAD (KG)	WHEEL ABR	MAX LOAD (KG)	WHEEL ABR	MAX LOAD (KG)	OVERALL HEIGHT (mm)	SWIVEL RADIUS (mm)
										
75		MSR07532	-NNI	130	-TPB	80	-UPB	80	115	N/A
100		MSR10032	-NNI	140	-TPB	100	-UPB	100	139	
125		MSR12532	-NNI	150	-TPB	110	-UPB	110	162	
75		MSS07532	-NNI	130	-TPB	80	-UPB	80	115	72
100		MSS10032	-NNI	140	-TPB	100	-UPB	100	139	78
125		MSS12532	-NNI	150	-TPB	110	-UPB	110	162	96
75		MSST07532	-NNI	130	-TPB	80	-UPB	80	115	114
100		MSST10032	-NNI	140	-TPB	100	-UPB	100	139	
125		MSST12532	-NNI	150	-TPB	110	-UPB	110	162	
75		MSH07532	-NNI	130	-TPB	80	-UPB	80	111	72
100		MSH10032	-NNI	140	-TPB	100	-UPB	100	135	78
125		MSH12532	-NNI	150	-TPB	150	-UPB	150	158	96
150		MSH15032	N/A	N/A	-TPB	125	-UPB	125	183	127
75		MSHT07532	-NNI	130	-TPB	80	-UPB	80	111	114
100		MSHT10032	-NNI	140	-TPB	100	-UPB	100	135	
125		MSHT12532	-NNI	150	-TPB	150	-UPB	150	158	
150		MSHT15032	N/A	N/A	-TPB	125	-UPB	125	183	

## WHEELS

WHEEL DIAMETER (mm)	TREAD WIDTH (mm)	WHEEL CODE	MAX LOAD (KG)	BORE DIAMETER (no spacer mm)	BORE DIAMETER (spacer mm)	HUB LENGTH (mm)	TREAD MATERIAL	CENTRE MATERIAL	BEARING TYPE	AXLE SPACER TYPE
										
75	32	NN07532I	130	15	8	38	NYLON	NYLON	PLAIN BORE	
100		NN10032I	140							
125		NN12532I	150							
75	32	TP07532SB	80	8	-	38	THERMOPLASTIC ELASTOMER	PP	STAINLESS PRECISION BEARINGS	-
100		TP10032SB	100							
125		TP12532SB	110							
150		TP15032SB	150							
75	32	UP07532SB	80	8	-	38	URETHANE	PP	STAINLESS PRECISION BEARINGS	-
100		UP10032SB	100							
125		UP12532SB	110							
150		UP15032SB	150							