

NY DZUS® Q-Latch Quarter-Turn Fasteners Assembly

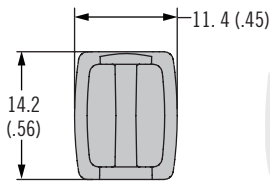

Latched



Unlatched

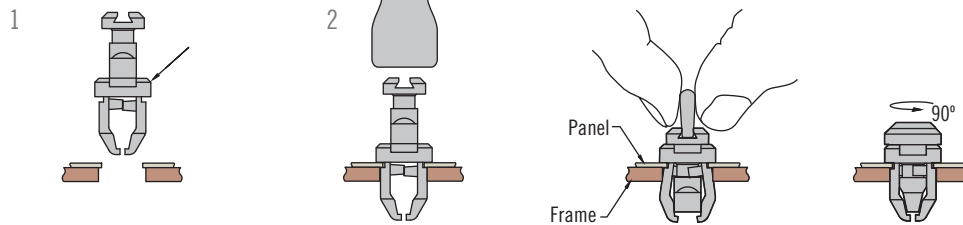
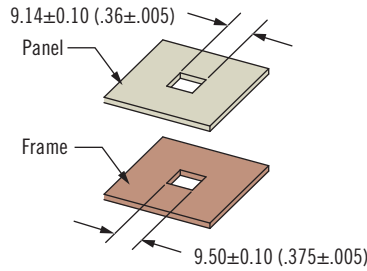
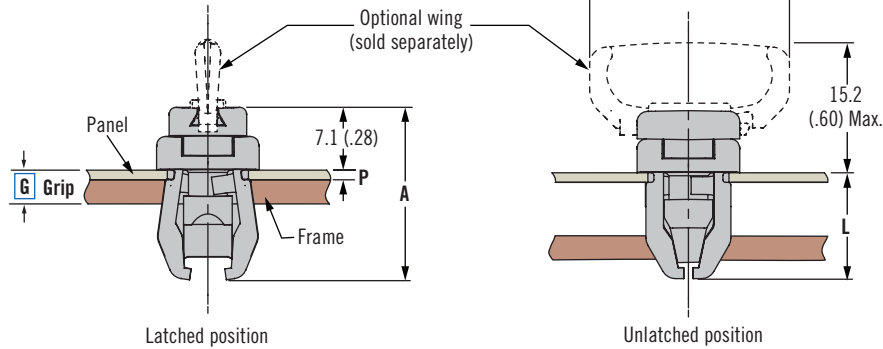
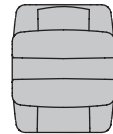

- Surface install
- Panel mounted assembly

Material and Finish

Polycarbonate, black or white

Flammability Rating:

UL94-V0

82

85

D8

D9

D1

D4

D5

D7

NY



NY Q-latch

Installation notes

1. Insert assembly into outer panel.
2. Strike head of assembly to captivate assembly into outer panel.
3. Turn stud 90 degree to latch and unlatch.
4. Slide wing into slot

Part Number Selection

Latch assembly shipped as one piece

Wing must be ordered separately

G	Haltebereich		P Max.	L	Latch Assembly Part Number	Finish
	Min.	Max.				
1	1.50	3.76	1.0	12.7	NY-N6-1-10	White
					NY-N6-1-20	Black
2	1.93	4.19	1.5	12.95	NY-N6-2-10	White
					NY-N6-2-20	Black
3	3.00	5.26	2.5	13.97	NY-N6-3-10	White
					NY-N6-3-20	Black
4	4.62	6.88	4.1	15.75	NY-N6-4-10	White
					NY-N6-4-20	Black

Option Wing Part Number (order separately)	Finish
NY-H6-10	White
NY-H6-20	Black

Installation Guidelines

for *SOUTHCO*® Self-Clinching products

Self-clinching product installation is offered on these *SOUTHCO*® products, making them easy-to-use captive panel fasteners:

- Captive Screws
- Receptacles for Quarter-turn Fasteners
- Receptacles for Fast-lead Thread Screws

When pressed into a properly prepared hole, self-clinching captive fasteners cold-flow (move) the panel material into the retaining groove of the fastener. This material then retains the fastener in the panel.

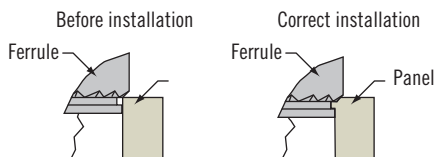

Successful press-in installations depend on:

Material:

The hardness of the panel material must not exceed *SOUTHCO*® recommendations. If the panel is too hard, the fastener will not install correctly.

Installation Holes:

Mounting holes may be drilled, punched, or cast.

- Hole edge: the top hole edge must be sharp but with no broken edges.

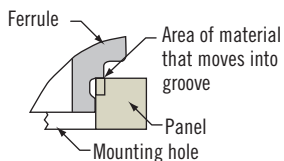

Do not chamfer or debur edge.

- Punched holes: use a punch and die with a small clearance to minimize the rollover and fracture angle.
- Hole diameter: measure the hole diameter at the panel surface on the side on which the fastener will be installed. The diameter must be within *SOUTHCO*® specifications for that product.

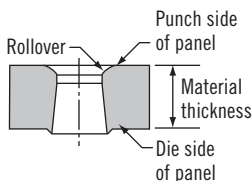

- If the hole is too large, not enough material will flow into the

retaining groove and the fastener may not be retained adequately.

- If the hole is too small, the fastener will not fit and installation may become difficult and unsafe.
- Hole distance from the edge of panel: the minimum recommended distance is 1.5 x the diameter of the mounting hole, unless otherwise indicated.

- Spring-loaded Plungers
- Captive Nuts
- Threaded Inserts

- Installing too close to the edge will cause the material to flow in the opposite direction, deforming the edge of the panel. To install closer to the edge, you may need to restrain the panel edge.

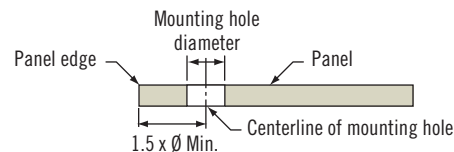

Panel Thickness:

The thickness of the panel at the mounting hole location must meet or exceed Southco's stated minimum recommendations.

If the material is too thin, panel deformation and/or damage to the fastener may result.

Installation is fast and easy if you follow these tips:

How to install: Use the recommended force where noted and a proper back-up tool.

- use any parallel-acting press
- use a punch whose diameter is larger than the head of the fastener

Installation Force: Proper installation requires an even distribution of adequate force. It does not depend on the distance the fastener is pressed into the panel.

- Southco does not recommend using a hammer. The impact force does not provide an even distribution of force to allow the panel material to completely flow into the fastener's retaining groove.
- Installation force varies from application to application, depending on the criteria noted above.
- On parts without a collar to provide a hard stop, press-in until the edge of the knurl is just barely visible.

When to Install:

Installation is recommended after plating or finishing has been applied to the panel.

The hole diameter must meet specifications before finish or plating is applied.

- Do not over-install parts. This interrupts the material and will reduce the retention strength.

