

R4 Rotary Latch

Striker bolt · Light-duty · Installation

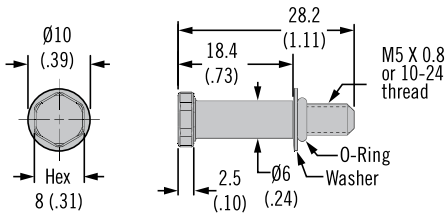

Striker Bolt (sold separately)



Striker Bolt Part Number		
Part Number	Thread	Material
R4-90-0511-10	10-24-UNC	Steel
R4-90-0511-20	10-24-UNC	Stainless Steel
R4-90-0521-10	M5 X 0.8	Steel
R4-90-0521-20	M5 X 0.8	Stainless Steel

Molded Striker (sold separately)

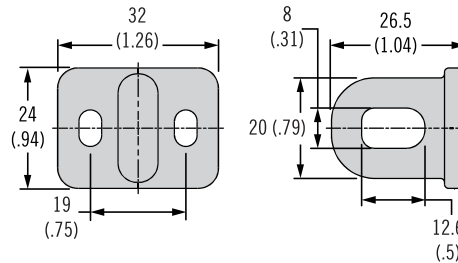

Part Number	
Molded striker	R4-0-61336

• Strikers for R4-05 series rotary latch

Material and Finish

Steel, zinc nickel, zinc plated, black zinc nickel, Stainless Steel

Part Number

See tables

Wire Form Strikers (sold separately)

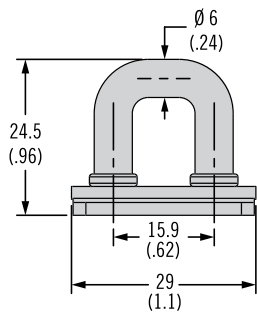

Single Hole Mount R4-90-0501-XX

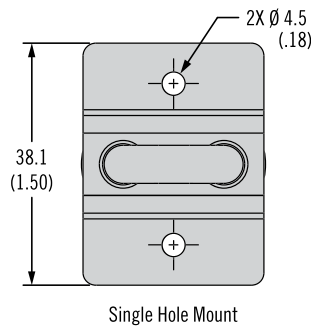

Slot Mount R4-90-0502-XX

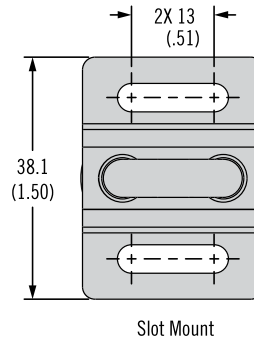

Wire Form Strikers		
Part Number	Mount	Material
R4-90-0501-10	Single Hole	Steel, Zinc Plated
R4-90-0501-15	Single Hole	Steel, Black Zinc Nickel
R4-90-0501-77	Single Hole	Steel, Zinc Nickel
R4-90-0502-10	Slot	Steel, Zinc Plated
R4-90-0502-15	Slot	Steel, Black Zinc Nickel
R4-90-0502-77	Slot	Steel, Zinc Nickel

R4 Rotary Latch

Striker bolt · Light-duty · Installation



Striker Bolt Assembly - Standard (sold separately)

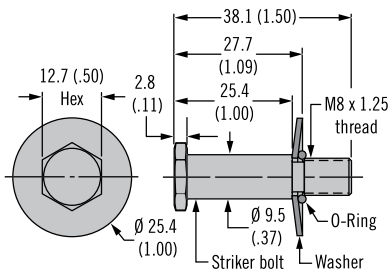

Striker Bolt Standard	
Part Number	Material
R4-90-121-10	Steel, Zinc Plated
R4-90-121-20	Stainless Steel

Striker Bolt Assembly - Integrated Bumper (sold separately)

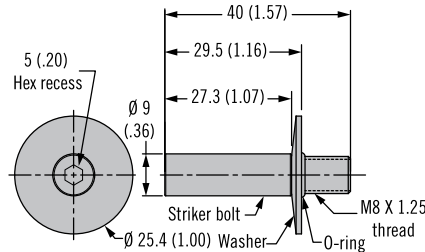

Striker Bolt Integrated Bumper	
Part Number	Material
R4-90-124-10	Steel, Zinc Plated
R4-90-124-20	Stainless Steel

• Strikers for R4-10 series rotary latch

Material and Finish

Steel, zinc plated Steel, zinc nickel plated, Steel, black zinc nickel plated, Stainless Steel, passivated

Operation

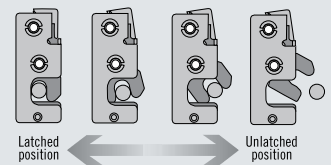

Part Number

See tables

Striker 90° Mounting Bracket

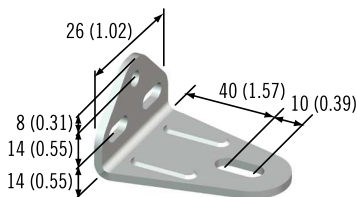

Striker Mounting Bracket	
Part Number	Material
R4-0-50114	Stainless Steel

Wire Form Strikers

(sold separately)

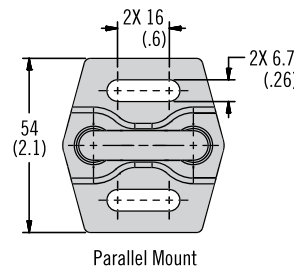
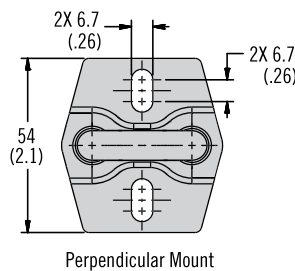
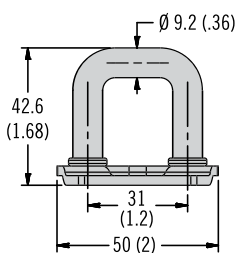

Wire Form Strikers - Standard Ø9.2 (.36)		
Part Number	Mount	Material
R4-90-101-10	Perpendicular	Steel, Zinc Plated
R4-90-101-15	Perpendicular	Steel, Black Zinc Nickel Plated
R4-90-101-77	Perpendicular	Steel, Zinc Nickel Plated
R4-90-102-10	Parallel	Steel, Zinc Plated
R4-90-102-15	Parallel	Steel, Black Zinc Nickel Plated
R4-90-102-77	Parallel	Steel, Zinc Nickel Plated

Wire Form Strikers - Integrated Bumper Ø9 (.35)		
Part Number	Mount	Material
R4-90-104-10	Perpendicular	Steel, Zinc Plated
R4-90-104-15	Perpendicular	Steel, Black Zinc Nickel Plated
R4-90-104-77	Perpendicular	Steel, Zinc Nickel Plated
R4-90-106-10	Parallel	Steel, Zinc Plated
R4-90-106-15	Parallel	Steel, Black Zinc Nickel Plated
R4-90-106-77	Parallel	Steel, Zinc Nickel Plated